

ENGINEER OF RECORD:
PLEASE VERIFY TORSIONAL
STABILITY OF BEAM.

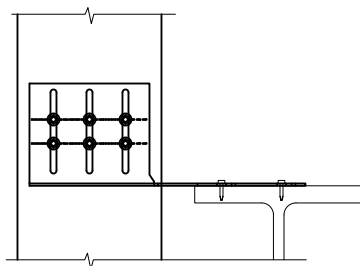

SIDE VIEW

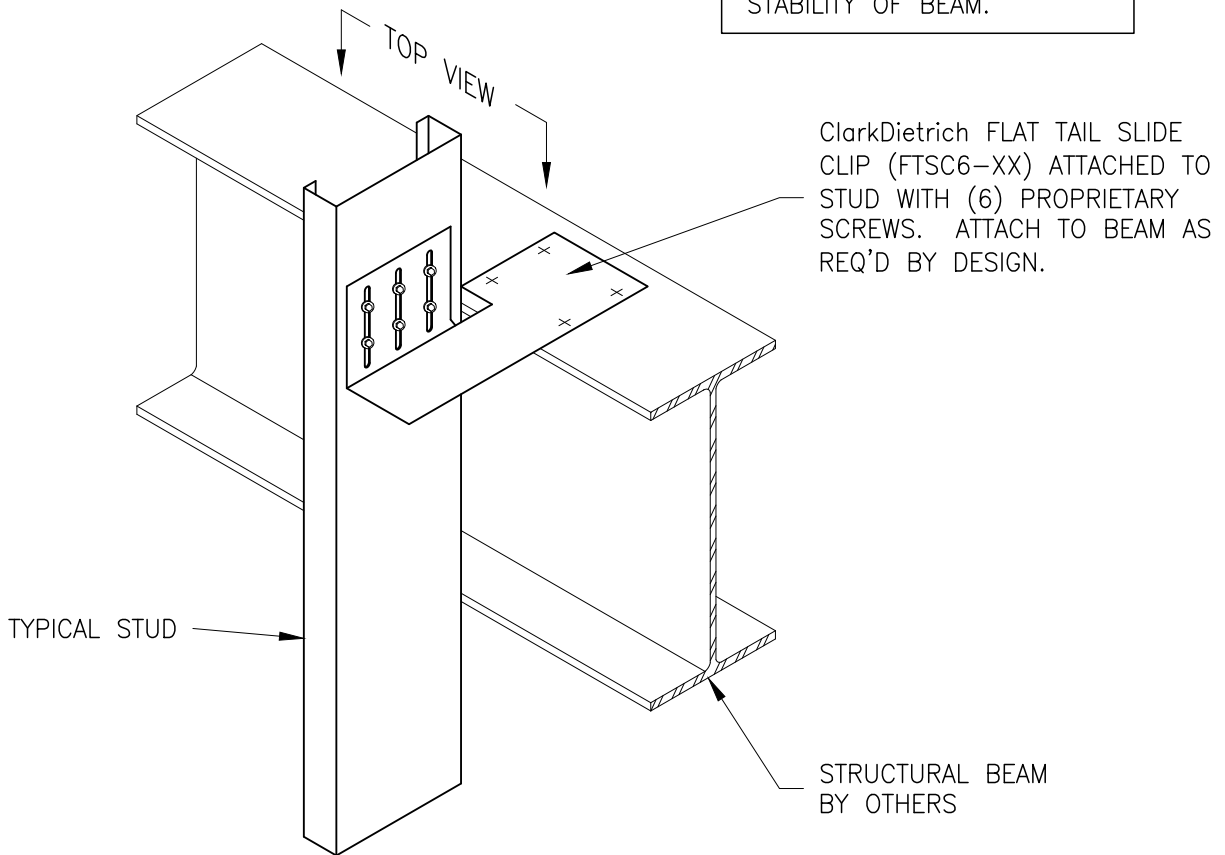
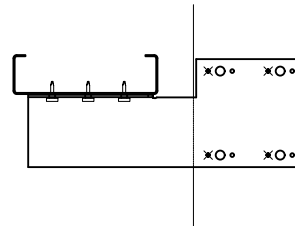

TOP VIEW

STUD CONNECTION WITH Flat Tail Slide Clip (FTSC6) TO TOP OF BEAM



Engineering Services: (877) 832-3206

Technical Services: (888) 437-3244

The CAD detail library is intended to provide general framing details only and does not replace the judgments and designs of a qualified architect and/or engineer. The details are provided as a starting tool to assist the user in creating and detailing cold-formed steel framing construction details. Each detail including accompanying text must be thoroughly evaluated and approved by a qualified architect or engineer. | Find over 500 CAD details at cad.clarkdietrich.com | © Copyright 2020 ClarkDietrich